

TECHNICAL DATA

ROLF BENZ 310



**ROLF
BENZ**

- Wooden inner frame
- Nosag spring support
- Back in polyurethane foam
- Seat in polyurethane foam, built up in coordinated layers varying in height and firmness
- Cover quilted underneath with non-woven polyester
- Brace metal optionally:
 - Stainless steel
 - Smooth steel, powder-coated, matt RAL 9017 traffic black

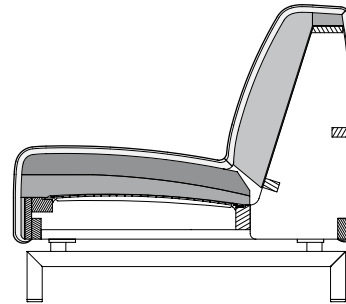

! High-quality, casual upholstery that forms waves/leaves indentations that are typical of the material. All measurements are approximate.

Sofa

Seat heights available

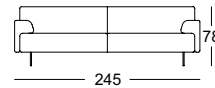
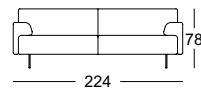
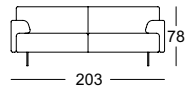
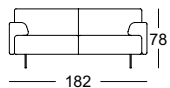
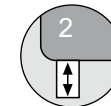

**ROLF
BENZ**

Sectional sofa*

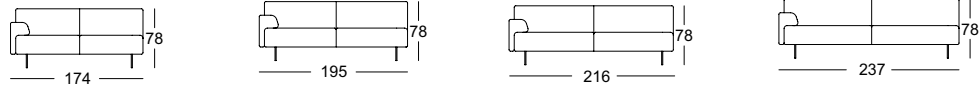

Corner modular sofa element*

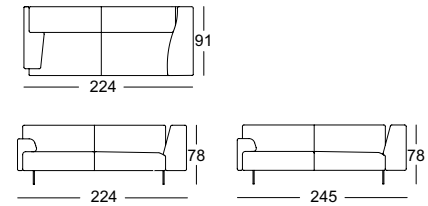

Corner sectional sofa*

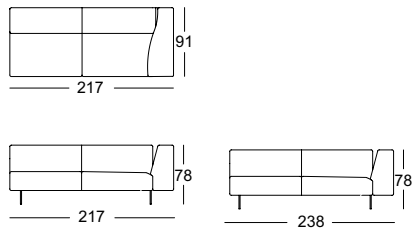

Sectional sofa with fixed footstool*

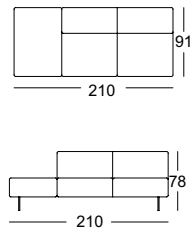

Corner sectional sofa with fixed footstool*

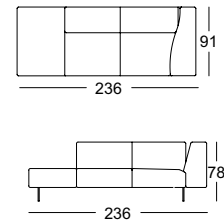

Upholstered bench

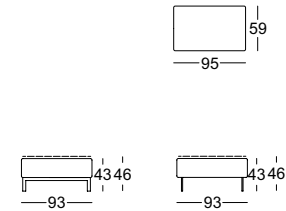

Combination examples:

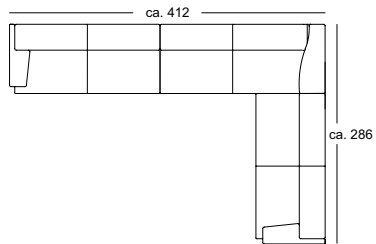

ASO 310/195 le.
E-ARB 310/217 le.
ASO 310/195 ri.

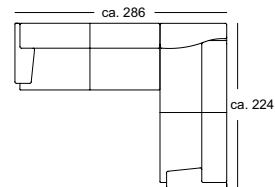

ASO 310/195 le.
E-ASO 3140/224 ri.

*These elements are only shown in the left version. They are also available in the right version.